



Technical Data Sheet

Bi-Color Top View LEDs

67-22USRSYGC/S530-A3/E3/TR8

Features

- P-LCC-4 package.
- Optical indicator.
- Ideal for backlight and light pipe application.
- Wide viewing angle.
- Suitable for vapor-phase reflow, Infrared reflow and wave solder processes.
- Computable with automatic placement equipment.
- Available on tape and reel (8mm Tape).
- Pb-free
- The product itself will remain within RoHS compliant version.



Descriptions

- The 67-22 series is available in soft orange, green, blue and yellow. Due to the package design, the LED has wide viewing angle and optimized light coupling by inter reflector, this feature makes the ideal for light pipe application. The low current requirement makes this device ideal for portable equipment or any other application where power is at a premium.

Applications

- Telecommunication: indicator and backlight in telephone and fax.
- Indicator and backlight for audio and video equipment.
- Indicator and backlight in office and family equipment.
- Flat backlight for LCD's, switches and symbols.
- Light pipe application.
- General use.

Device Selection Guide

Chip		Emitted Color	Resin Color
Material			
USR	AlGaInP	Dark - Red	Water Clear
SYG	AlGaInP	Brilliant Yellow Green	

Technical Data Sheet

Bi-Color Top View LEDs

67-22USRSYGC/S530-A3/E3/TR8

Package Dimensions

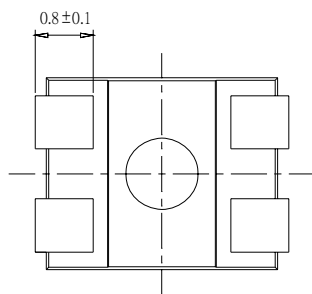
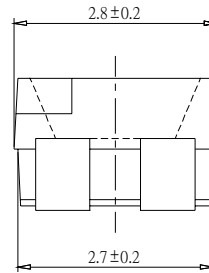
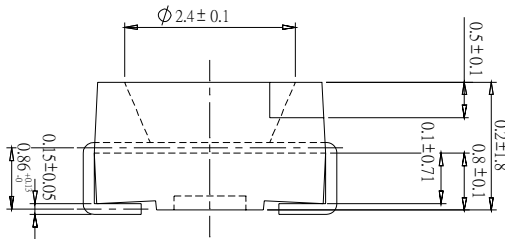
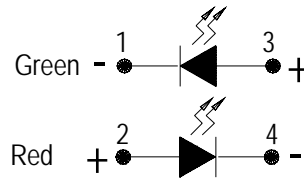
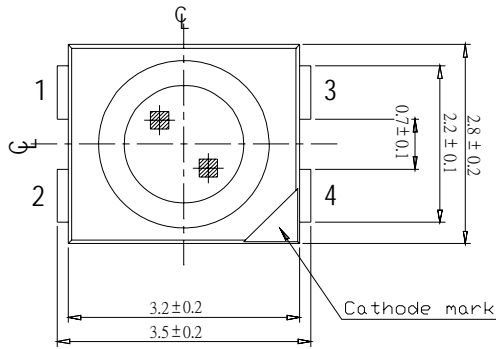

For reflow soldering (propose)

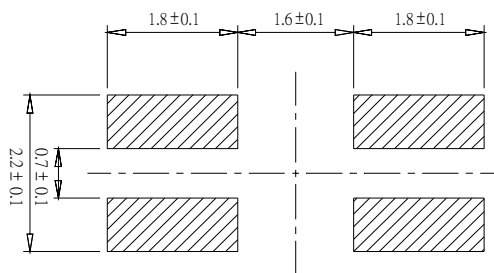

Note: The tolerances unless mentioned is ± 0.1 mm; Unit = mm

**Technical Data Sheet****Bi-Color Top View LEDs****67-22USRSYGC/S530-A3/E3/TR8****Absolute Maximum Ratings Ta=25°C**

Parameter	Symbol	Rating	Unit
Reverse Voltage	V_R	5	V
Forward Current	I_F	USR:25	mA
		SYG:25	
Peak Forward Current (Duty 1/10 @1KHz)	I_{FP}	USR:60	mA
		SYG:60	
Power Dissipation	P_d	USR:60	mW
		SYG:60	
Electrostatic Discharge(HBM)	ESD	USR:2000	V
		SYG:2000	
Operating Temperature	T_{opr}	-40 ~ +85	°C
Storage Temperature	T_{stg}	-40~ +90	°C
Soldering Temperature	T_{sol}	Reflow Soldering : 260 °C for 10 sec. Hand Soldering : 350 °C for 3 sec.	



Technical Data Sheet

Bi-Color Top View LEDs

67-22USRSYGC/S530-A3/E3/TR8

Electro-Optical Characteristics Ta=25°C

Parameter	Symbol	Min.	Typ.	Max.	Unit	Condition	
Luminous Intensity	I _v	USR	25	46	-----	mcd	I _F =20mA
		SYG	30	48	-----		
Viewing Angle	2θ 1/2	-----	120	-----	deg	I _F =20mA	
Peak Wavelength	λ _p	USR	-----	639	-----	nm	I _F =20mA
		SYG	-----	575	-----		
Dominant Wavelength	λ _d	USR	-----	631	-----	nm	I _F =20mA
		SYG	-----	573	-----		
Spectrum Radiation Bandwidth	Δλ	USR	-----	20	-----	nm	I _F =20mA
		SYG	-----	20	-----		
Forward Voltage	V _F	USR	-----	2.0	2.4	V	I _F =20mA
		SYG	-----	2.0	2.4		
Reverse Current	I _R	-----	-----	10	μA	V _R =5V	

Technical Data Sheet

Bi-Color Top View LEDs

67-22USRSYGC/S530-A3/E3/TR8

Typical Electro-Optical Characteristics Curves (USR)

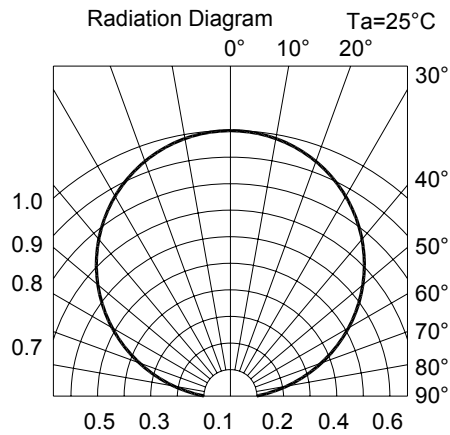
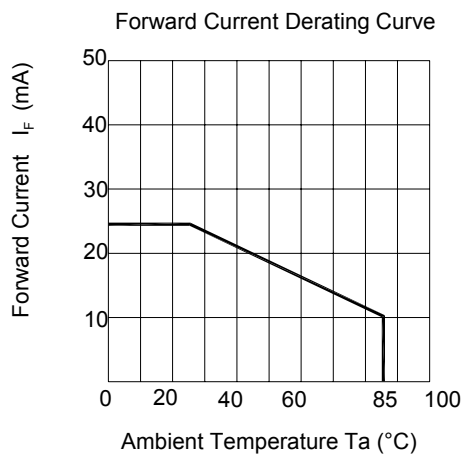
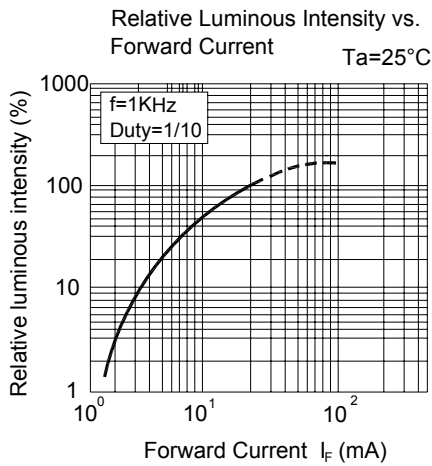
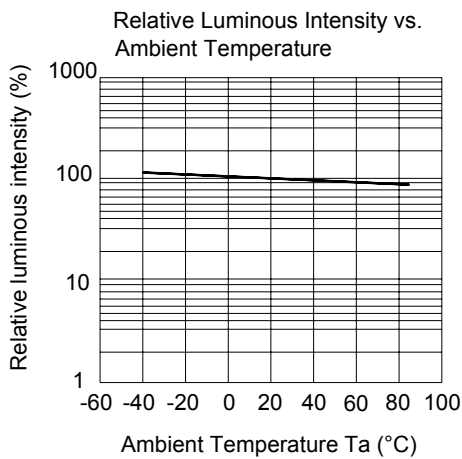
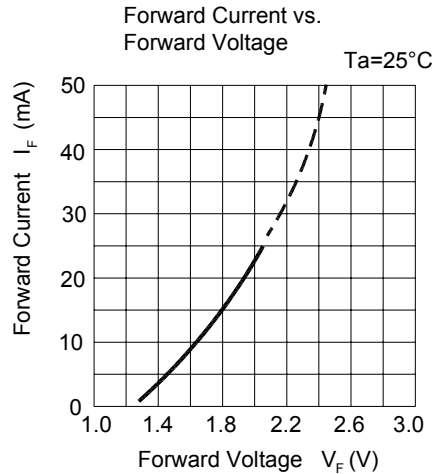
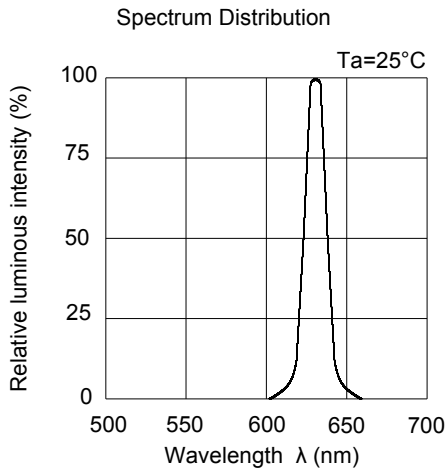

Technical Data Sheet

Bi-Color Top View LEDs

67-22USRSYGC/S530-A3/E3/TR8

Typical Electro-Optical Characteristics Curves (SYG)

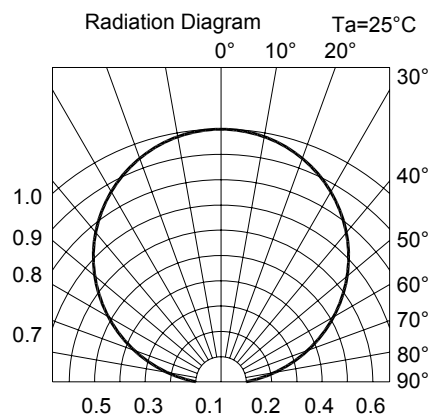
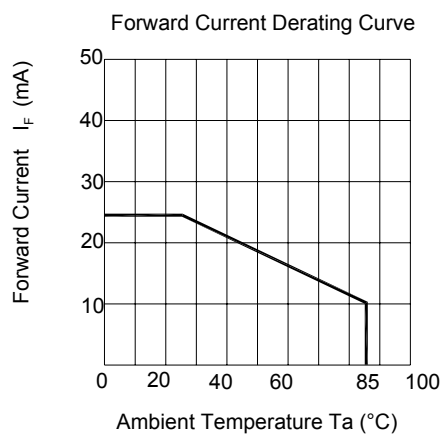
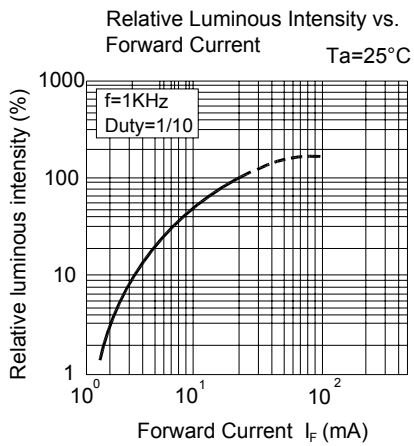
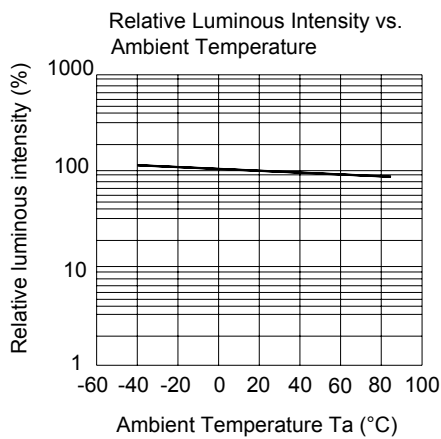
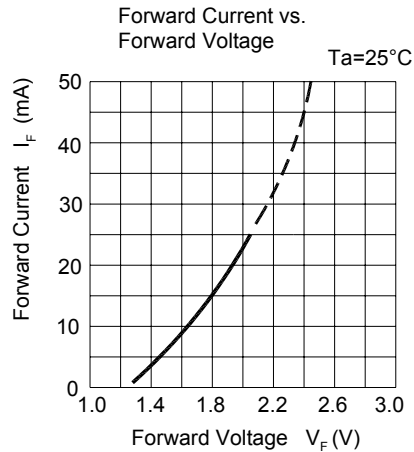
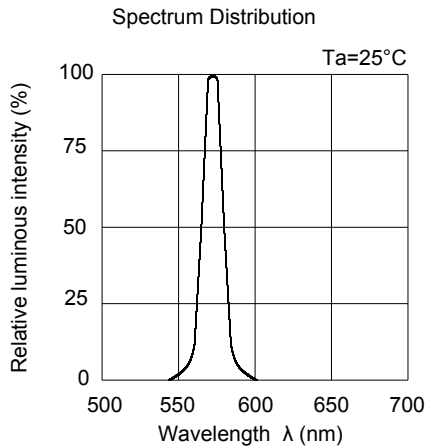



Technical Data Sheet

Bi-Color Top View LEDs

67-22USRSYGC/S530-A3/E3/TR8

Label Explanation

CAT: Luminous Intensity Rank

HUE: Dom. Wavelength Rank

REF: Forward Voltage Rank

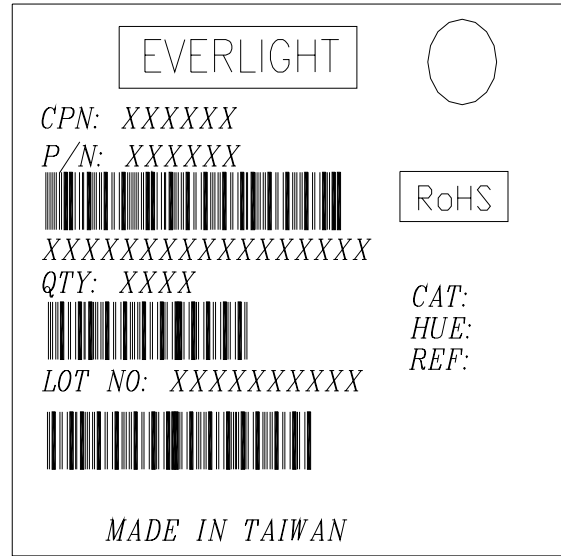

Reel Dimensions

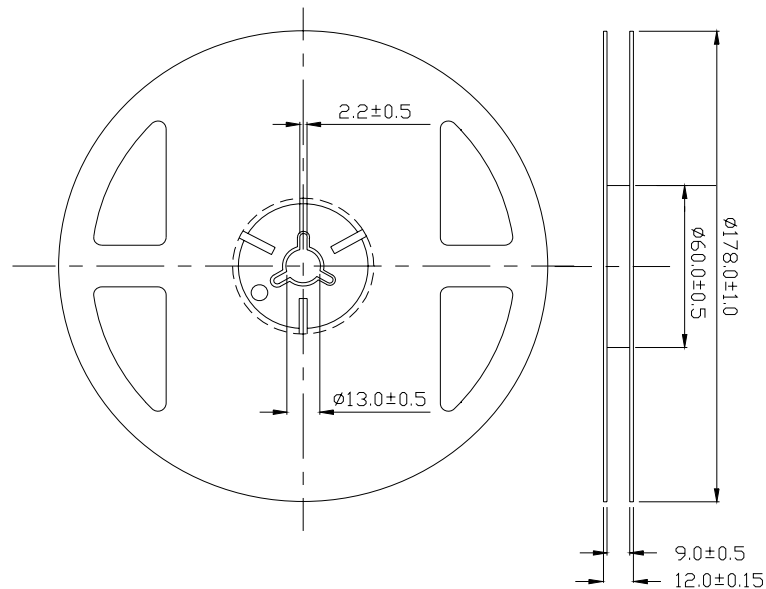

Note: Tolerance unless mentioned is ±0.1mm; Unit = mm

Technical Data Sheet

Bi-Color Top View LEDs

67-22USRSYGC/S530-A3/E3/TR8

Carrier Tape Dimensions: Loaded Quantity 2000 pcs Per Reel.

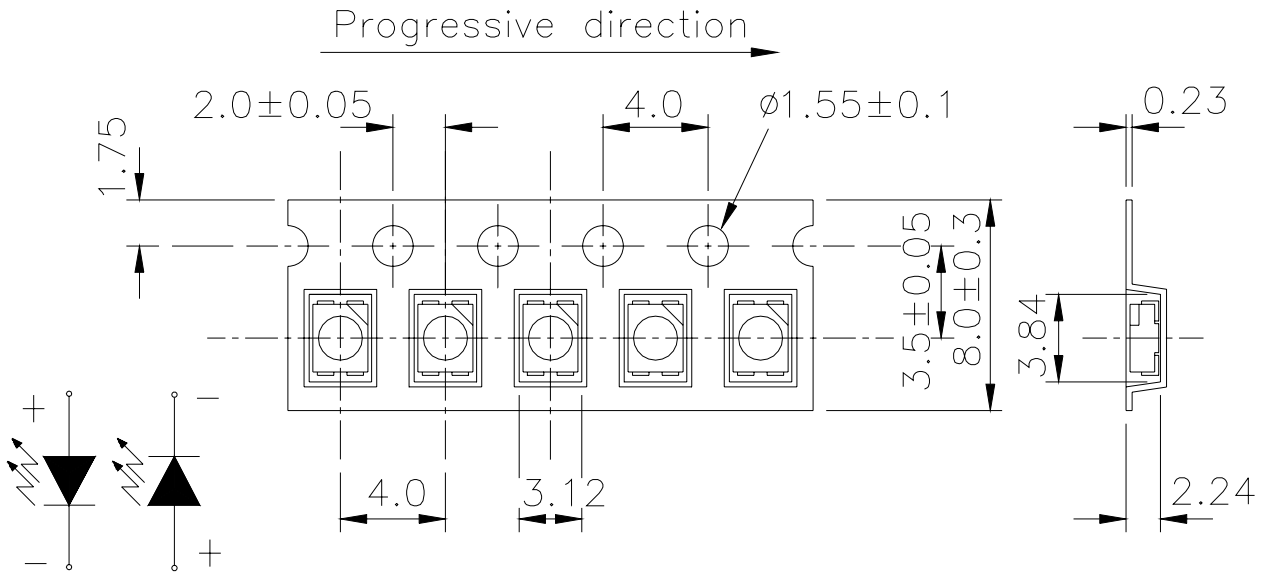

Moisture Resistant Packaging

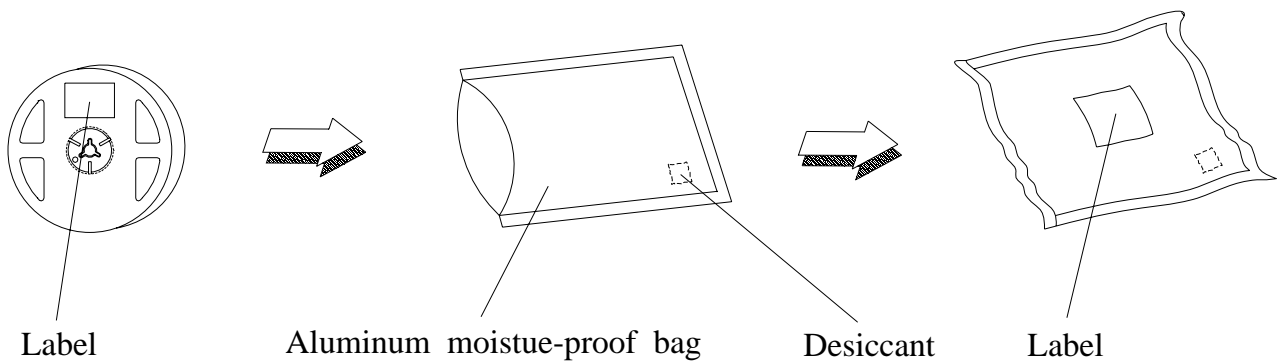

**Technical Data Sheet****Bi-Color Top View LEDs****67-22USRSYGC/S530-A3/E3/TR8****Reliability Test Items and Conditions**

The reliability of products shall be satisfied with items listed below.

Confidence level : 90%

LTPD : 10%

No.	Items	Test Condition	Test Hours/Cycles	Sample Size	Ac/Re
1	Reflow Soldering	Temp. : 260°C ±5°C Min. 5sec.	6 Min.	22 PCS.	0/1
2	Temperature Cycle	H : +100°C 15min ∫ 5 min L : -40°C 15min	300 Cycles	22 PCS.	0/1
3	Thermal Shock	H : +100°C 5min ∫ 10 sec L : -10°C 5min	300 Cycles	22 PCS.	0/1
4	High Temperature Storage	Temp. : 100°C	1000 Hrs.	22 PCS.	0/1
5	Low Temperature Storage	Temp. : -40°C	1000 Hrs.	22 PCS.	0/1
6	DC Operating Life	I _F = 20 mA	1000 Hrs.	22 PCS.	0/1
7	High Temperature / High Humidity	85°C / 85%RH	1000 Hrs.	22 PCS.	0/1

Technical Data Sheet**Bi-Color Top View LEDs****67-22USRSYGC/S530-A3/E3/TR8****Precautions for Use**

1. Over-current-proof

Customer must apply resistors for protection, otherwise slight voltage shift will cause big current change (Burn out will happen).

2. Storage

2.1 Do not open moisture proof bag before the products are ready to use.

2.2 Before opening the package: The LEDs should be kept at 30°C or less and 90%RH or less.

2.3 After opening the package: The LED's floor life is 1 year under 30 deg C or less and 60% RH or less. If unused LEDs remain, it should be stored in moisture proof packages.

2.4 If the moisture absorbent material (silica gel) has faded away or the LEDs have exceeded the storage time, baking treatment should be performed using the following conditions.

Baking treatment : 60±5°C for 24 hours.

3. Soldering Condition

3.1 Pb-free solder temperature profile

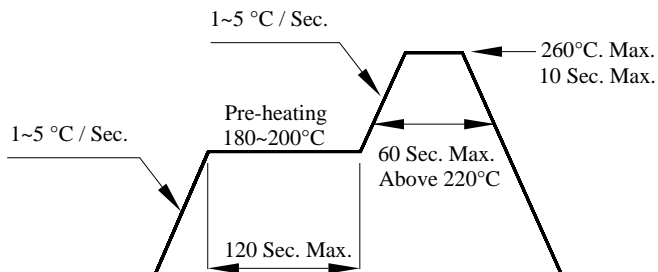

3.2 Reflow soldering should not be done more than two times.

3.3 When soldering, do not put stress on the LEDs during heating.

3.4 After soldering, do not warp the circuit board.

Technical Data Sheet**Bi-Color Top View LEDs****67-22USRSYGC/S530-A3/E3/TR8****4. Soldering Iron**

Each terminal is to go to the tip of soldering iron temperature less than 350°C for 3 seconds within once in less than the soldering iron capacity 25W. Leave two seconds and more intervals, and do soldering of each terminal. Be careful because the damage of the product is often started at the time of the hand solder.

5. Repairing

Repair should not be done after the LEDs have been soldered. When repairing is unavoidable, a double-head soldering iron should be used (as below figure). It should be confirmed beforehand whether the characteristics of the LEDs will or will not be damaged by repairing.

